A blue-toned architectural rendering of a modern building. The building features a prominent glass facade on one side and a more solid, dark facade on the other. The rendering is a perspective view, showing the building's form and its reflection on a wet surface in the foreground. The overall aesthetic is clean and professional.

Izložba arhitektonskih radova  
mr. Sabrija Bilalić, dipl.ing.arh.

**od IDEJE do REALIZACIJE**

MUZEJ KNJIŽEVNOSTI I POZORIŠNE UMJETNOSTI BIH (GALERIJA MAK)  
Ulica Sime Milutinovića Sarajlije 7, Sarajevo

08.-15. NOVEMBRA 2007.

IZLOŽBA ARHITEKTONSKIH RADOVA "OD IDEJE DO REALIZACIJE"

AUTOR: mr. Sabrija Bilalić dipl.ing.arh.

GALERIJA MAK

GRAFIČKA OBRADA I PREIPREMA

Amar Ćudić dipl.ing.arh.

amarcudic@gmail.com

PRINT

Shtamparija d.o.o. Tuzla

www.shtamparija.com

TIRAŽ

500 komada



Pre do uvarno pomava same te, Sabije,  
itkluđino kao nlo stumkog, vijeanaog i oasovomog  
faraamika. kromog i pmoictjirog.

Dauer, pin pit, kotlije tnoo aetit zodine, puko  
kilođenoq albuma trojic profenala i malizacije,  
ukomajem te - pijatno imenađem - i kao izmetno  
uđpjetnog i pmoaktimog pmojenta - graditelje  
Talentiranog i pempentimog fakodan.

Trojje natolođeno graditeljno itkultro  
emplicitna je i izmetna vijeanaot i kvalitel  
u pmoagotnom radu te študentima pomovođali  
te u kumijam da čiš za mali uđpjetno koititili.

Zapađa u, mođaloum, kako te troj radvoj  
đilio i mmođio kmođtantno metiđi. Takradijueđ  
trojoj pmođiođnoj maljivođi i ukommođi, ti čit  
tra te praktična tarmanja, vjemjmu, umjeli  
generivali; mođ oadredena teoretika tarmanja  
Na pmođmetu, potebno kao što je troj, ni samo  
komarvanje pmođe i graditeljnog itkultro, ni  
samo pomarvanje teoretikih mađela i mitli  
teđto ču emprominati kmođetnog pmođagoga - arkitektu.

Na tebi je da potencijale koje kotjeanpi  
sada suplementivali te teoretikim mađelima i time  
kotjeanpi dođtojan sljedbenik Trojic pmođhodine.

Tako čit, Sabije, mođi do pmođijali ođuvanje  
tradicije; ađgitek pmođmeta pmođredue zgrade  
Zlatko Ugljen

Povodom upriličenja prve samostalne izložbe arhitektonskih radova autora mr. Sabrije Bilalića, dipl.ing.arh.,  
Akademik Prof. Zlatko Ugljen, dipl.ing.arh. napisao je:

Pre do uvarno pomava same te, Sabije,  
itkluđino kao nlo stumkog, vijeanaog i oasovomog  
faraamika. kromog i pmoictjirog.

Dauer, pin pit, kotlije tnoo aetit zodine, puko  
kilođenoq albuma trojic profenala i malizacije,  
ukomajem te - pijatno imenađem - i kao izmetno  
uđpjetnog i pmoaktimog pmojenta - graditelje  
Talentiranog i pempentimog fakodan.

Trojje natolođeno graditeljno itkultro  
emplicitna je i izmetna vijeanaot i kvalitel  
u pmoagotnom radu te študentima pomovođali  
te u kumijam da čiš za mali uđpjetno koititili.

Zapađa u, mođaloum, kako te troj radvoj  
đilio i mmođio kmođtantno metiđi. Takradijueđ  
trojoj pmođiođnoj maljivođi i ukommođi, ti čit  
tra te praktična tarmanja, vjemjmu, umjeli  
generivali; mođ oadredena teoretika tarmanja  
Na pmođmetu, potebno kao što je troj, ni samo  
komarvanje pmođe i graditeljnog itkultro, ni  
samo pomarvanje teoretikih mađela i mitli  
teđto ču emprominati kmođetnog pmođagoga - arkitektu.

Na tebi je da potencijale koje kotjeanpi  
sada suplementivali te teoretikim mađelima i time  
kotjeanpi dođtojan sljedbenik Trojic pmođhodine.

Tako čit, Sabije, mođi do pmođijali ođuvanje  
tradicije; ađgitek pmođmeta pmođredue zgrade  
Zlatko Ugljen

Povodom upriličenja prve samostalne izložbe arhitektonskih radova autora mr. Sabrije Bilalića, dipl.ing.arh.,  
Akademik Prof. Zlatko Ugljen, dipl.ing.arh. napisao je:

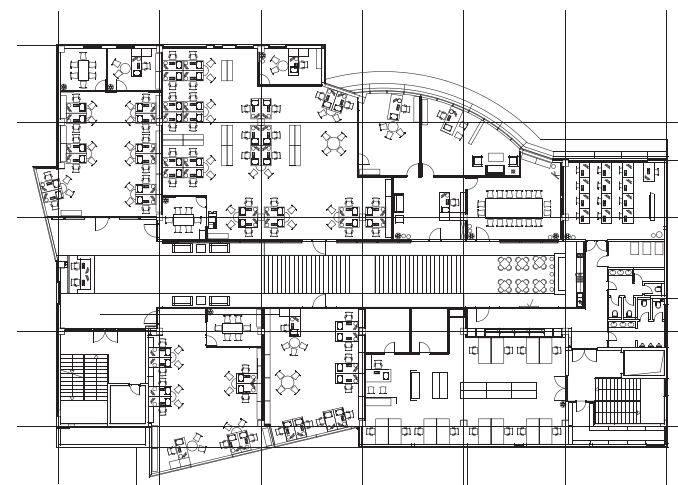

OSNOVA II KATA

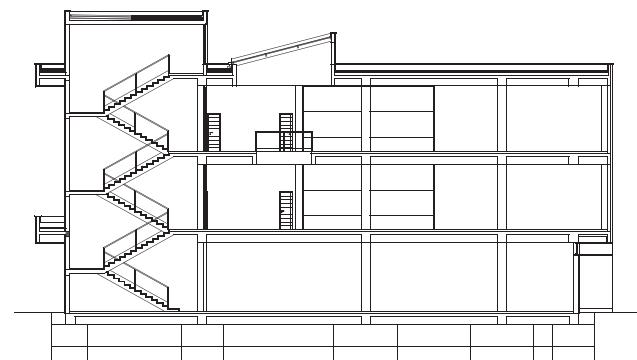

KARAKTERISTIČNI PRESJEK



## COM TRADE GROUP Tehnološki centar Sarajevo

INVESTITOR: COM TRADE GROUP LOKACIJA: SARAJEVO STATUS: IDEJA (2005) I REALIZACIJA (2006) PROJEKTANT ENTERIJERA: ARGENTARIJA

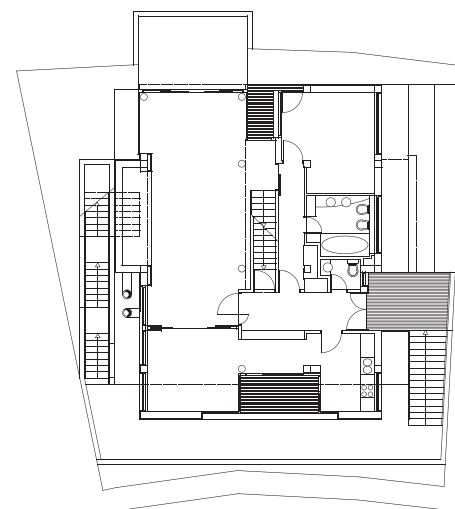

OSNOVA PRIZEMLJA

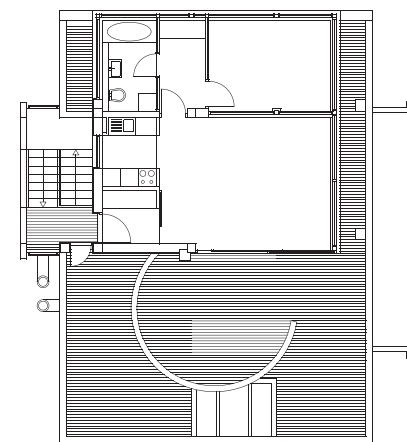

OSNOVA POTKROVLJA



**VILA HODŽIĆ** Individualni stambeni objekat  
Sarajevo

INVESTITOR: I. HODŽIĆ LOKACIJA: SARAJEVO STATUS: IDEJA (1999) I REALIZACIJA (2002) / KOAUTOR: mr. ADNAN PAŠIĆ dipl.Ing.arh.

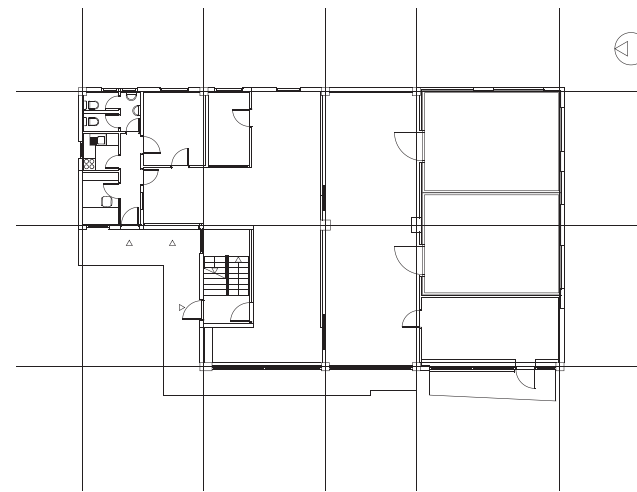

OSNOVA PRIZEMLJA

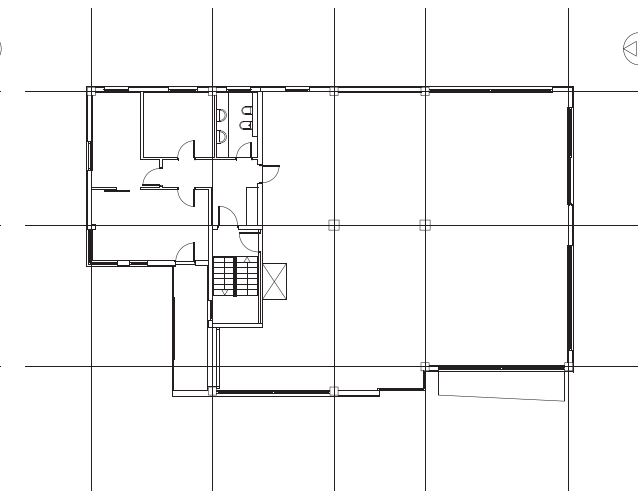

OSNOVA KATA



**VINOJUG I** | Poslovno-proizvodni objekat  
Sarajevo

INVESTITOR: A. GADŽO LOKACIJA: SARAJEVO STATUS: IDEJA (2002) I REALIZACIJA (2003)

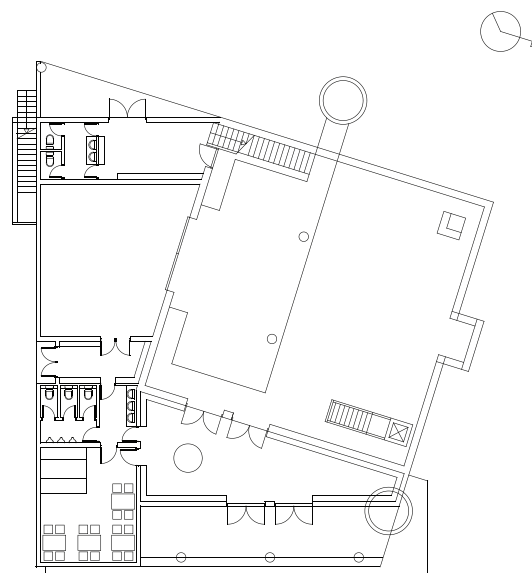

OSNOVA PRIZEMLJA

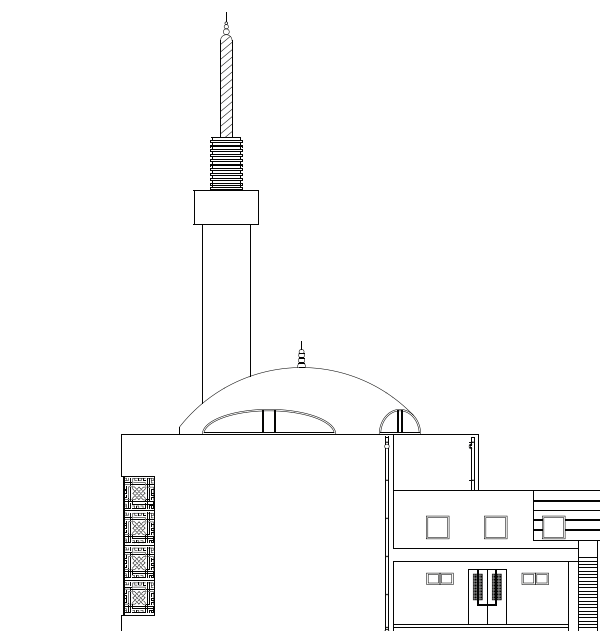

KARAKTERISTIČNA FASADA



## DŽAMIJA OSJEK | Vjerski objekat Ilidža, Sarajevo

INVESTITOR: ISLAMSKA VJERSKA ZAJEDNICA LOKACIJA: ILIDŽA, SARAJEVO STATUS: IDEJA (2003) | REALIZACIJA (2006)

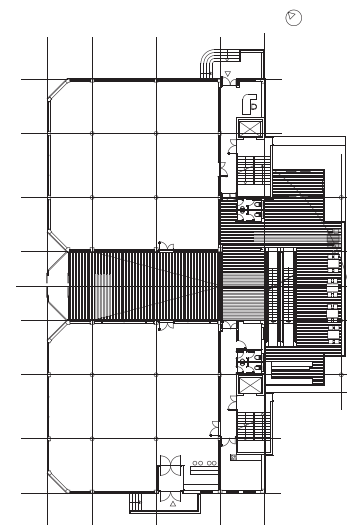

OSNOVA PRIZEMLJA

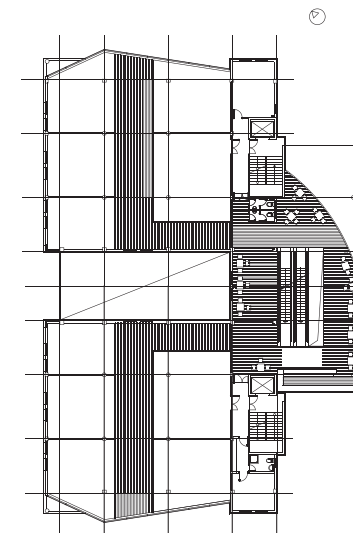

OSNOVA I KATA

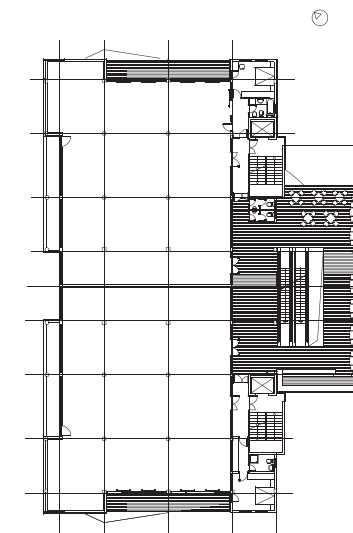

OSNOVA III KATA



**NERZZ** Poslovni objekat  
Visoko  
INVESTITOR: "NERZZ" BEŠLAGIĆ LOKACIJA: VISOKO STATUS: IDEJA (2003) I REALIZACIJA (2007 U TOKU)



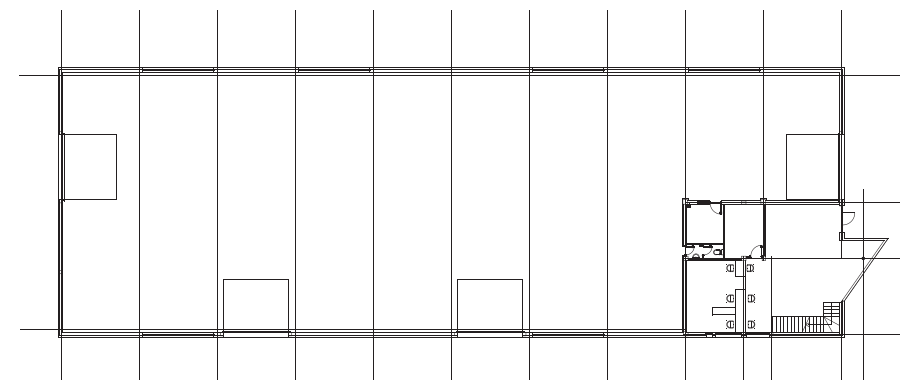
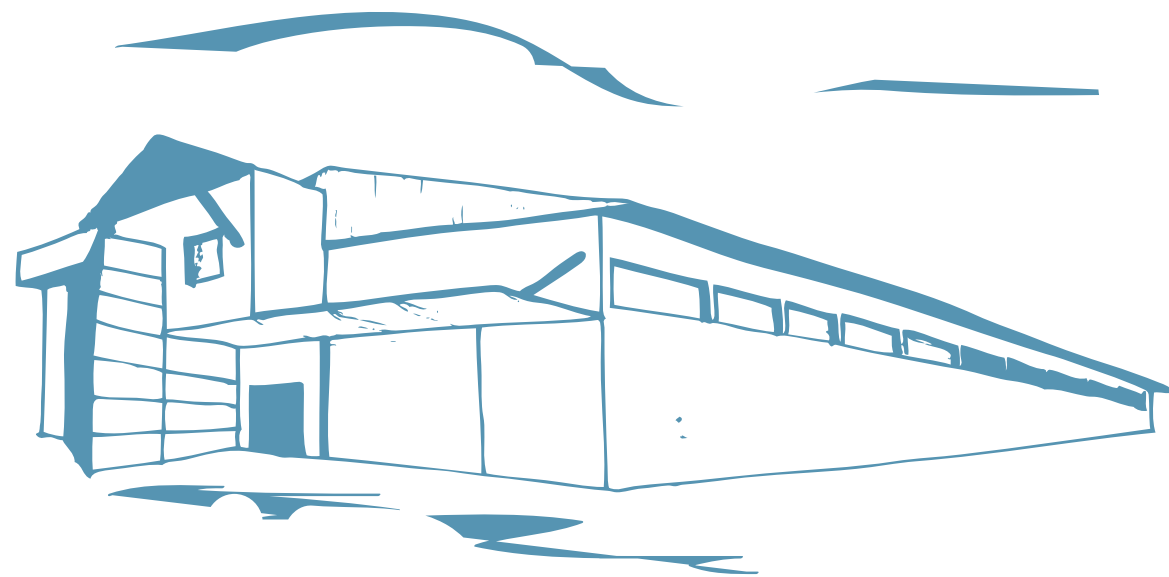

OSNOVA PRIZEMLJA

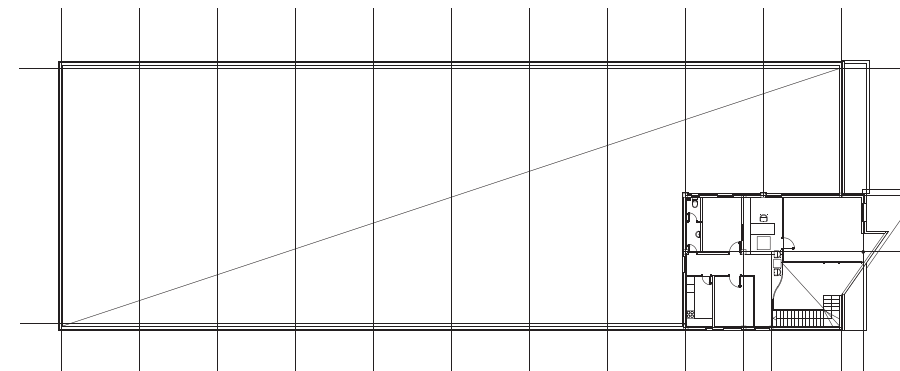

OSNOVA KATA



**ATRAKTIV** | Rekonstrukcija skladišnog objekta  
Sarajevo

INVESTITOR: ATRAKTIV D.O.O. LOKACIJA: SARAJEVO STATUS: IDEJA (2003) I REALIZACIJA (2004)

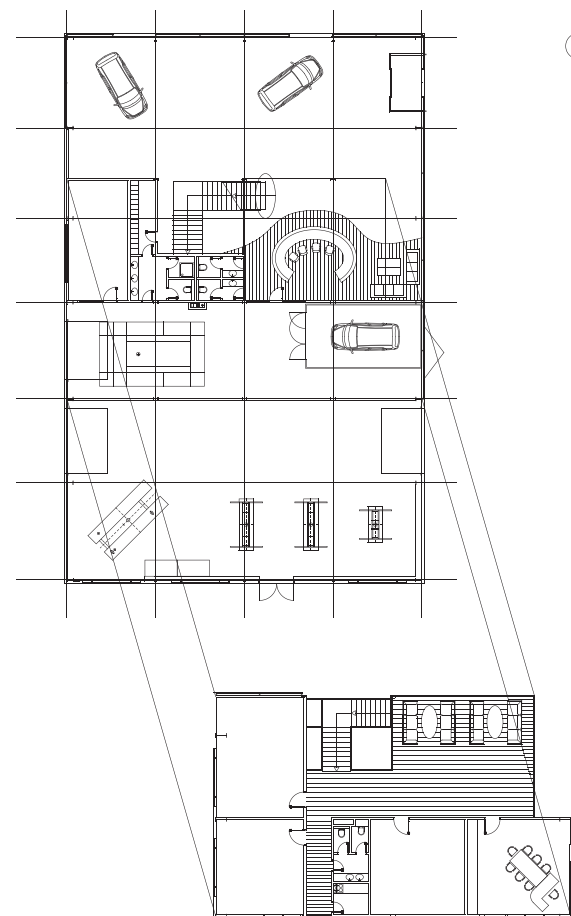

**HYUNDAI** | Autosalon i servisni objekat  
Kosovo Polje, Kosovo

INVESTITOR: "NIC" HOLDING LOKACIJA: KOSOVO STATUS: IDEJA (2004) I REALIZACIJA (2005) / KOAUTOR: FIKRET HRNJICA dipl.ing.arh.

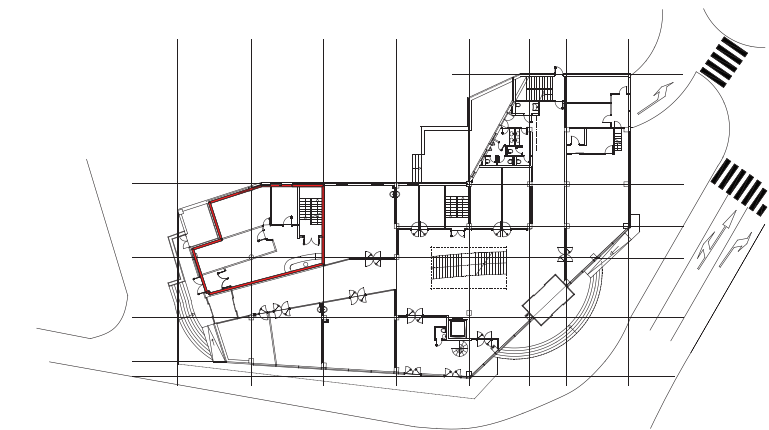

OSNOVA PRIZEMLJA

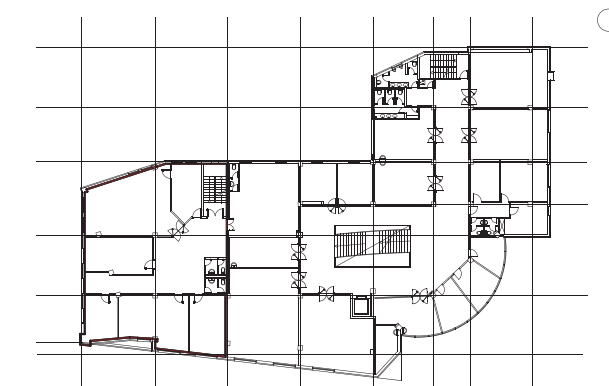

OSNOVA I KATA

**VIZIJA** | Poslovni objekat  
 Visoko  
 INVESTITOR: VIZIJA D.O.O. LOKACIJA: VISOKO STATUS: IDEJA (2004) I REALIZACIJA (2005)

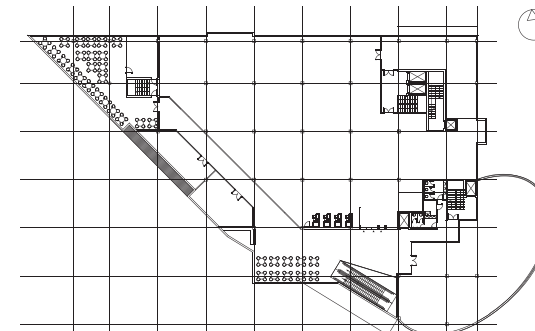

OSNOVA II KATA

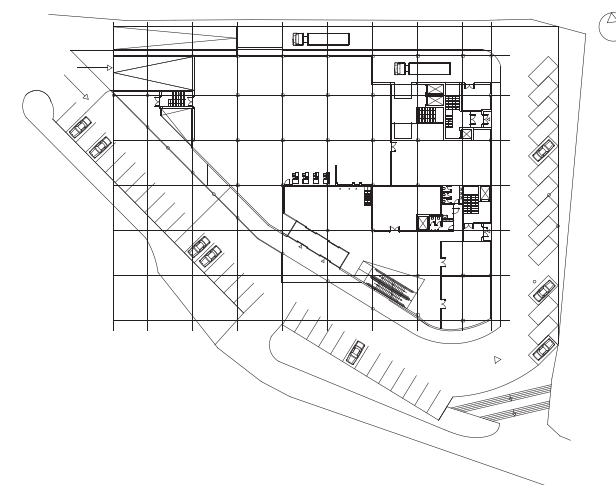

OSNOVA PRIZEMLJA

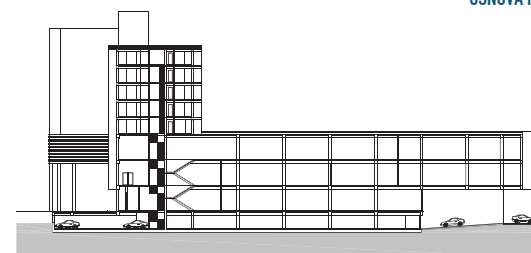

PRESJEK

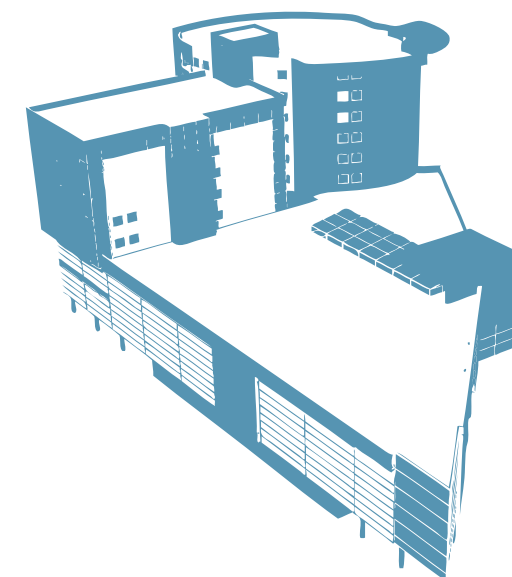

**ZVIJEZDA** | Stambeno-poslovni objekat  
Visoko

LOKACIJA: VISOKO STATUS: IDEJA (2007) / KOAUTOR: HASRET OMANOVIĆ dipl.Ling.arh.

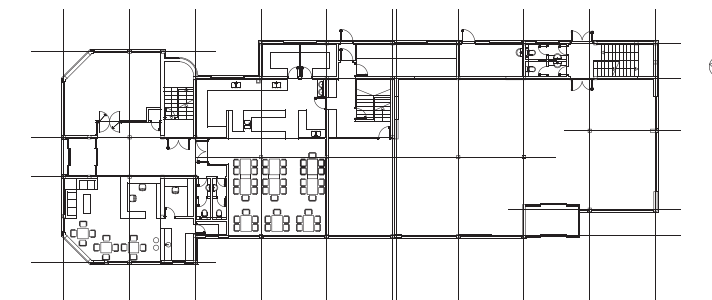

OSNOVA PRIZEMLJA

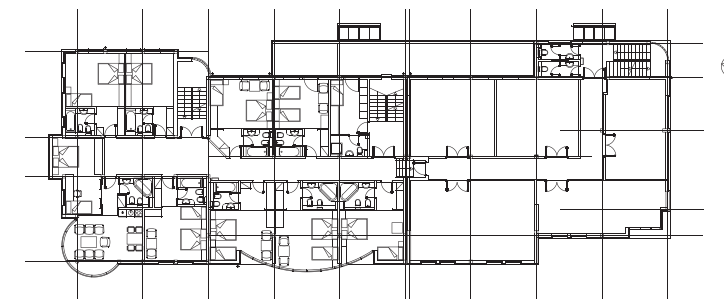

OSNOVA I KATA

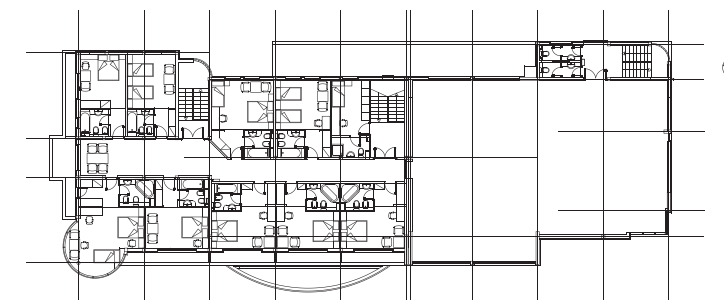

OSNOVA II KATA

**HALIX** Proizvodno-poslovni centar  
Prijeđor

INVESTITOR: HALID MUSLIMOVIĆ LOKACIJA: PRIJEĐOR STATUS: IDEJA (2005) I REALIZACIJA (2007 U TOKU)

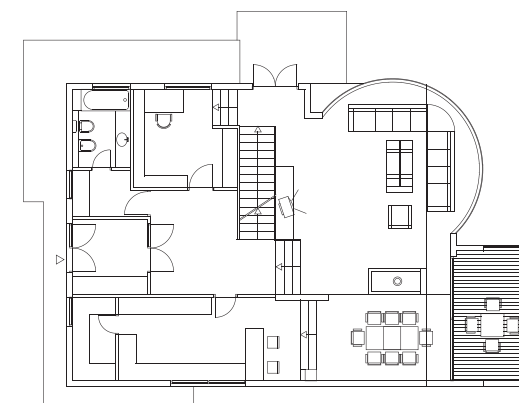
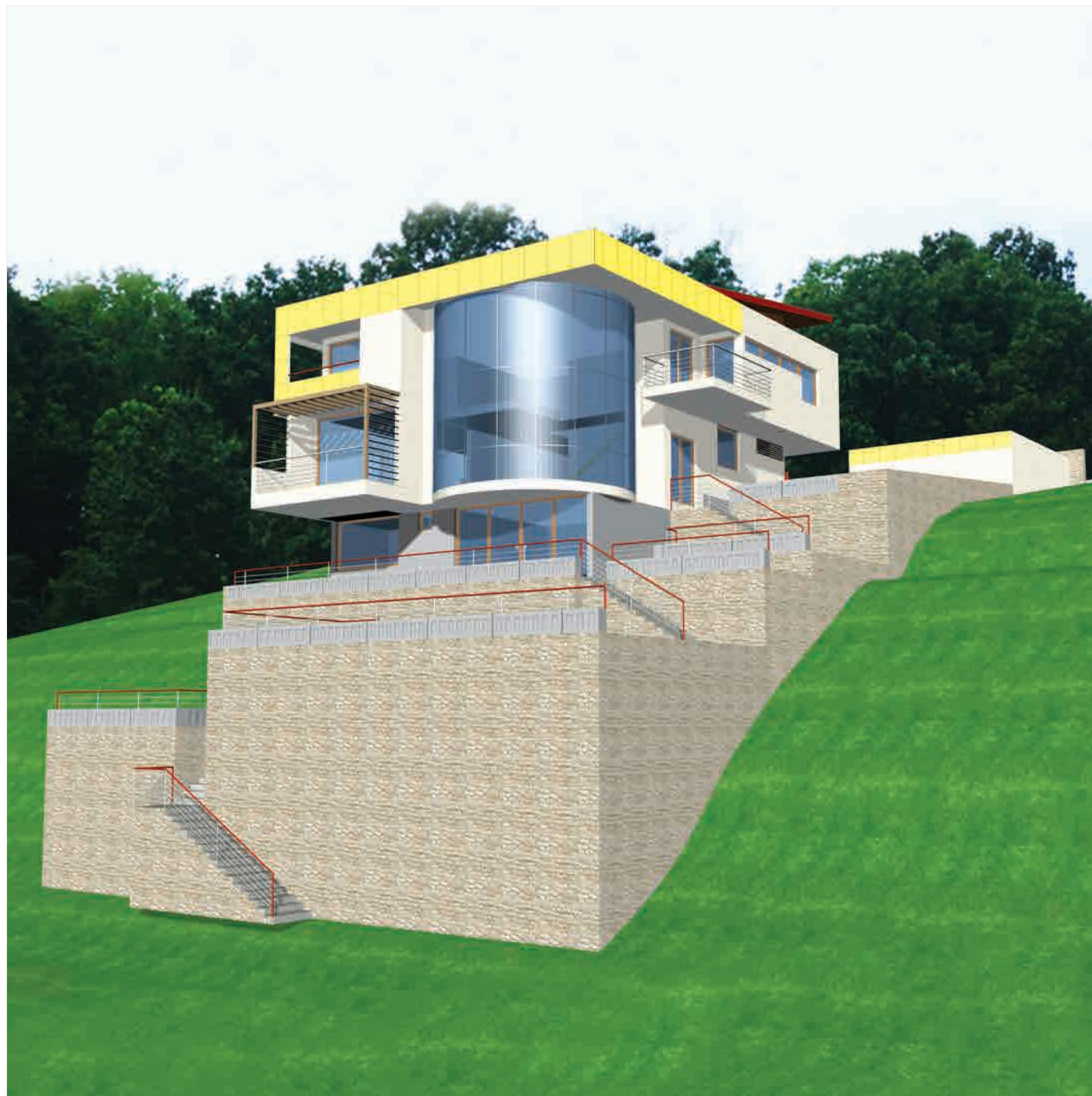

OSNOVA PRIZEMLJA

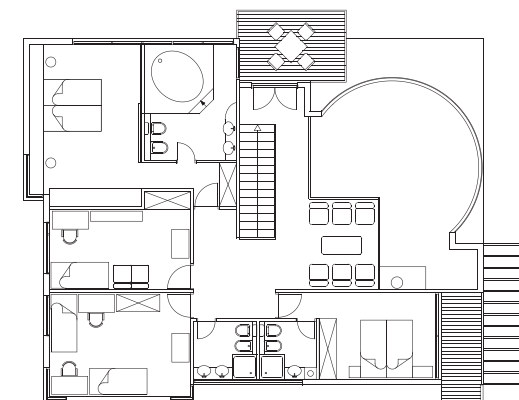

OSNOVA I KATA

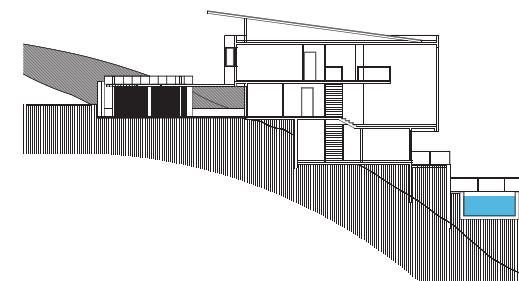

PRESJEK

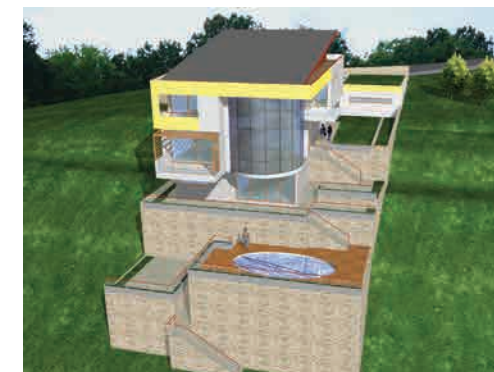

**VILA BEŠIĆ** | Individualni stambeni objekat  
Sarajevo  
INVESTITOR: OBITELJ BEŠIĆ LOKACIJA: SARAJEVO STATUS: IDEJA (2005)

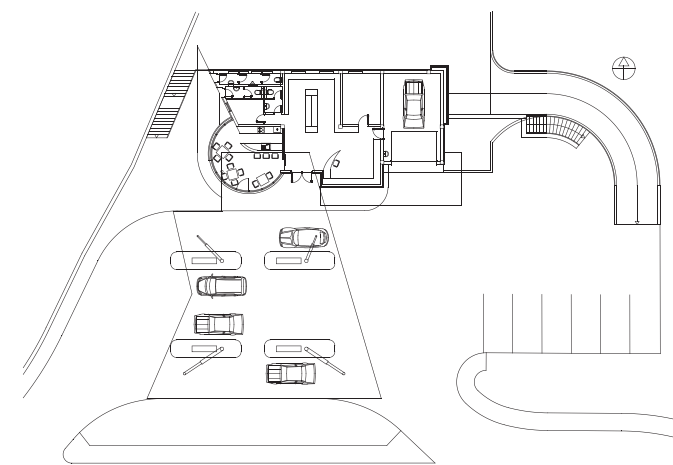

OSNOVA PARTERA

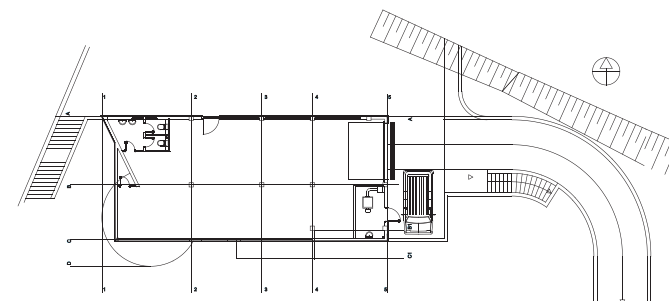

OSNOVA SUTERENA



**HAMSEL** | Benzińska pumpa  
Vogošća

INVESTITOR: HAMSEL D.O.O. LOKACIJA: VOGOŠĆA STATUS: IDEJA (2004) I REALIZACIJA (2005)

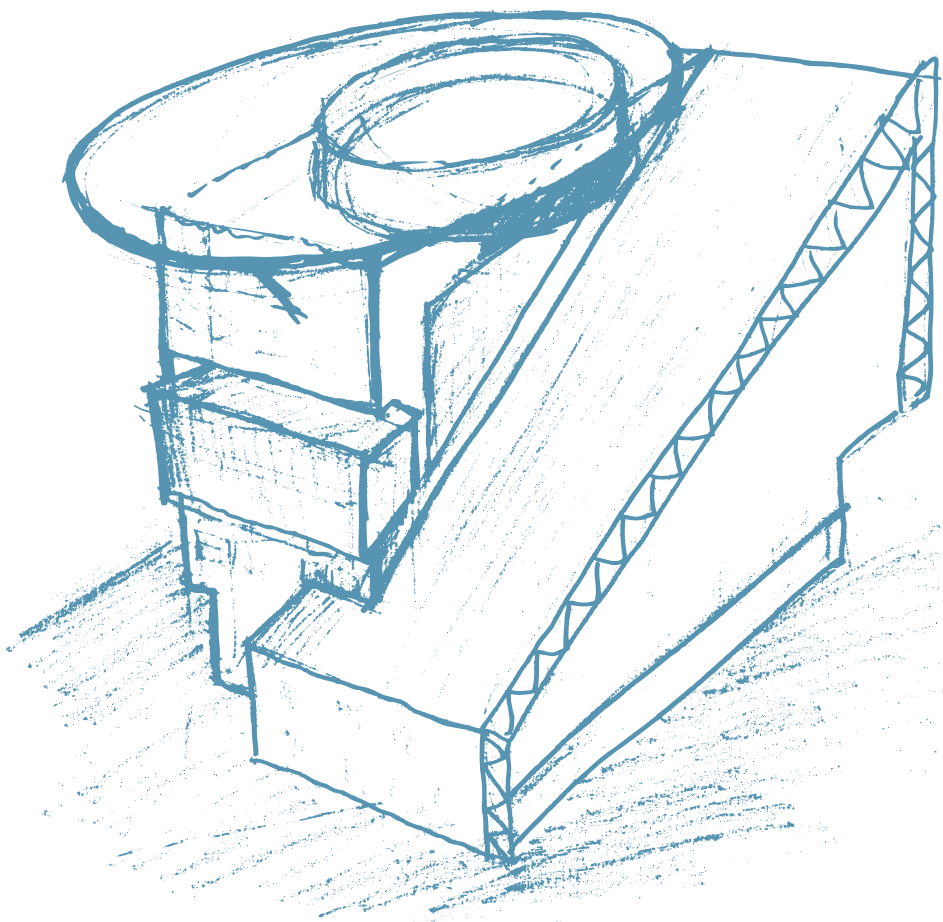

SPERANJE V OBRAT  
JULIJA

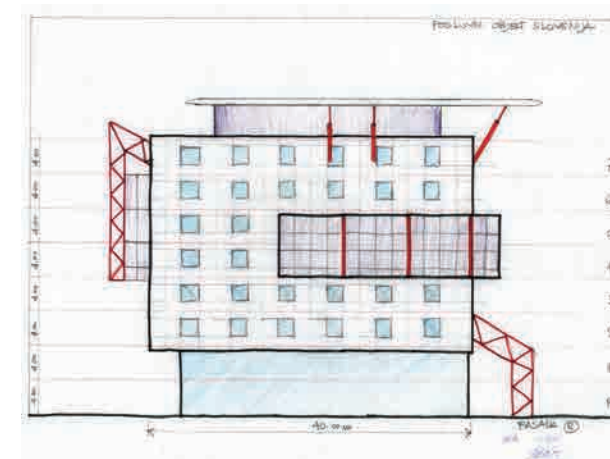
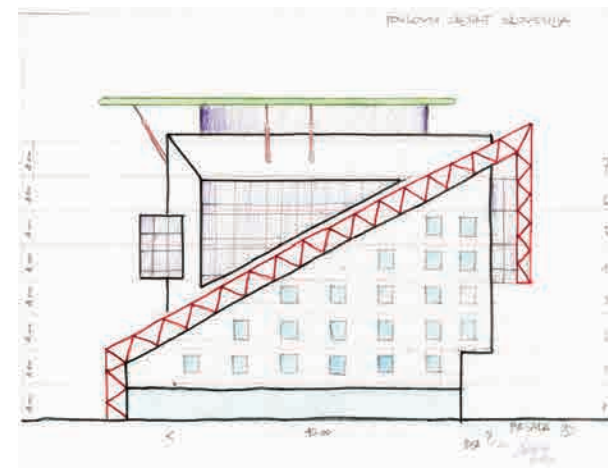

**BUSINESS CENTER** | Poslovni objekt  
Slovenija  
LOKACIJA: MARIBOR, SLOVENIJA STATUS: IDEJA (2005)



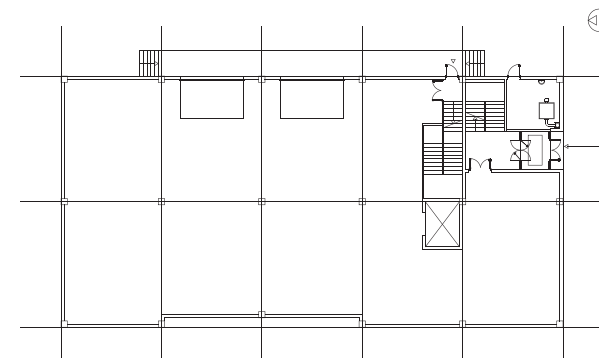

OSNOVA PRIZEMLJA

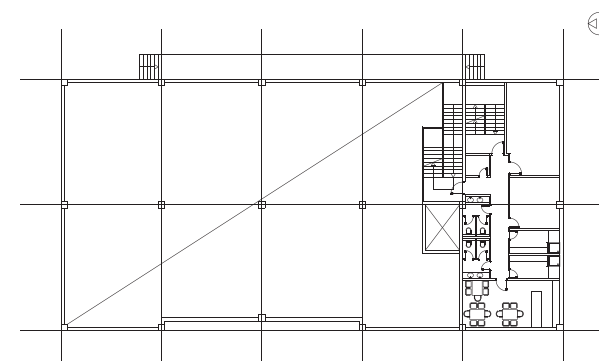

OSNOVA MEĐUETAŽE

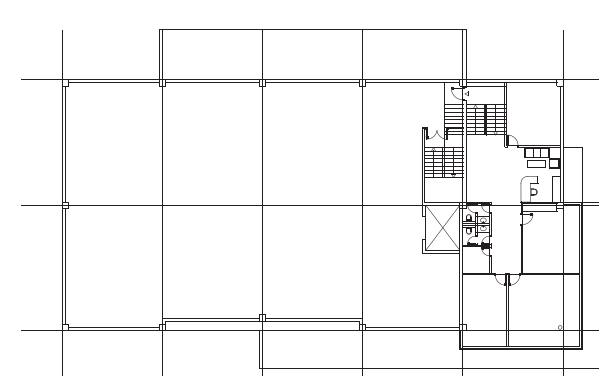

OSNOVA KATA



**BALCO-COMPANY** Poslovno-proizvodni objekat  
Vlakovo, Ilidža  
INVESTITOR: BALCO-COMPANY D.O.O. LOKACIJA: VLAKOVO, ILIDŽA STATUS: IDEJA (2004) I REALIZACIJA (2007 U TOKU)

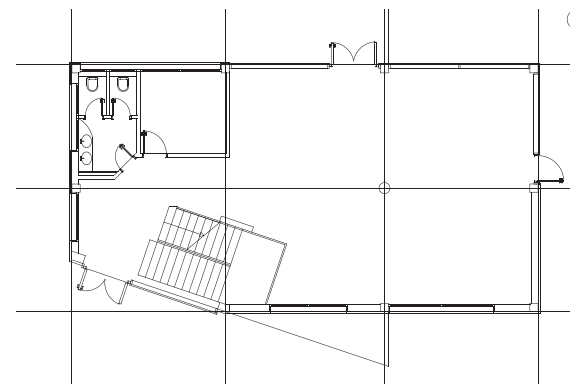

OSNOVA PRIZEMLJA

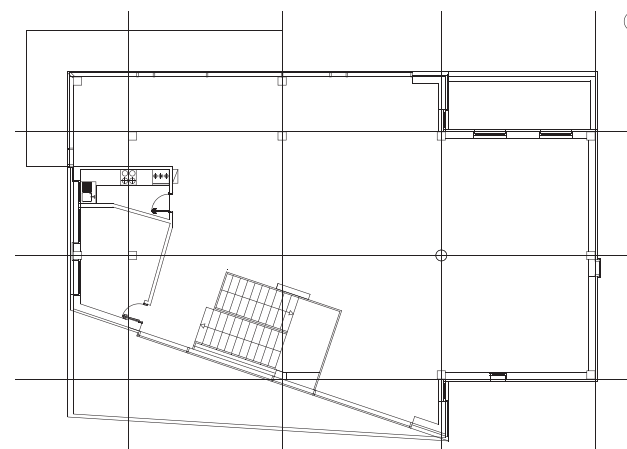

OSNOVA KATA



**BAGATELA** | Robna kuća  
Vogošća  
INVESTITOR: BEŠLIJA A. LOKACIJA: VOGOŠĆA STATUS: IDEJA (2006) I REALIZACIJA (2007)

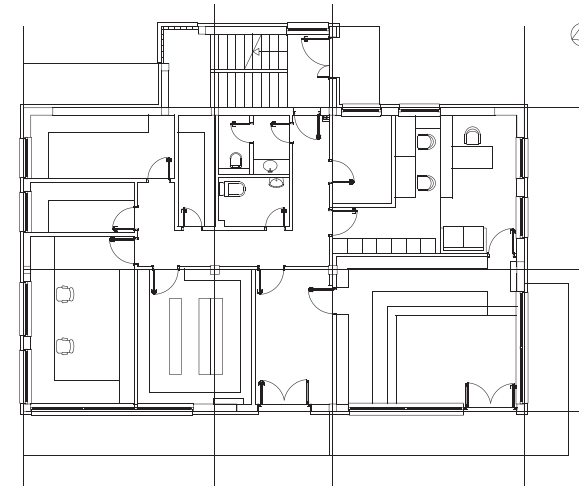

OSNOVA PRIZEMLJA

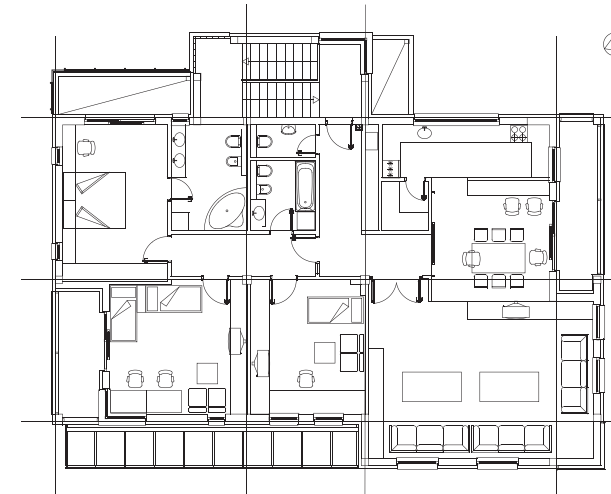

OSNOVA KATA



**APOTEKA** | Stambeno-poslovni objekat  
Osijek, Ilidža  
INVESTITOR: ČORBO A. LOKACIJA: OSJEK, ILIDŽA STATUS: IDEJA (2006) I REALIZACIJA (2007)

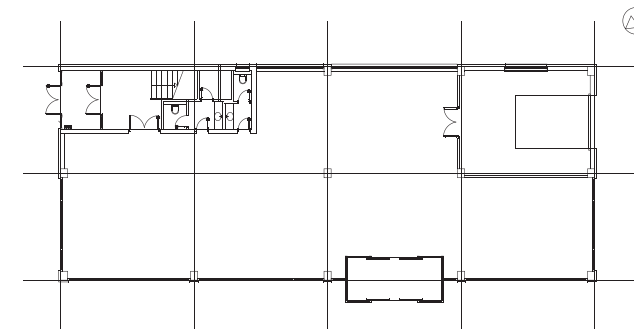

OSNOVA PRIZEMLJA

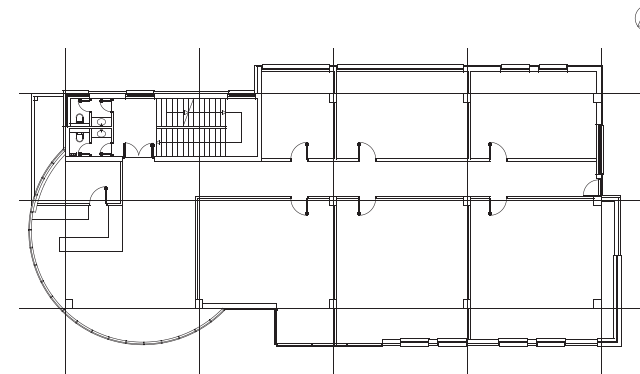

OSNOVA KATA



**BRADA** | Poslovni objekat  
Stup, Sarajevo  
INVESTITOR: DRAGOLOVČANIN N. LOKACIJA: STUP, SARAJEVO STATUS: IDEJA (2006) I REALIZACIJA (2007 U TOKU)

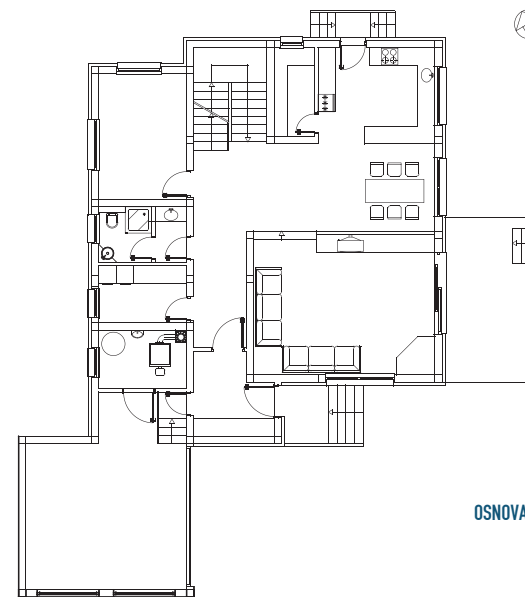

OSNOVA PRIZEMLJA

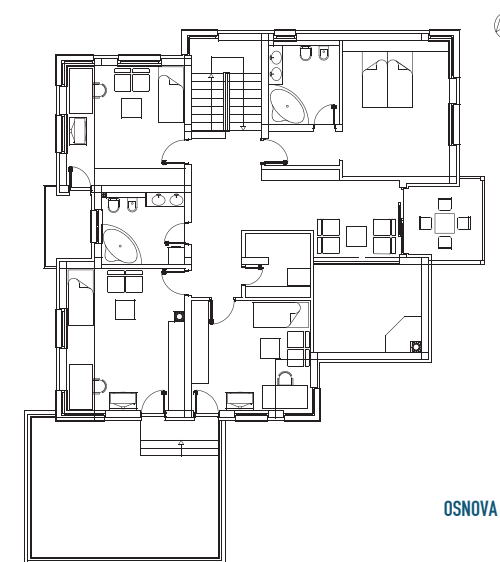

OSNOVA POTKROVLJA



**VILA HUREM** | Individualni stambeni objekat  
Sarajevo

INVESTITOR: HUREM Š. LOKACIJA: SARAJEVO STATUS: IDEJA (2007) I REALIZACIJA (2007 U TOKU)

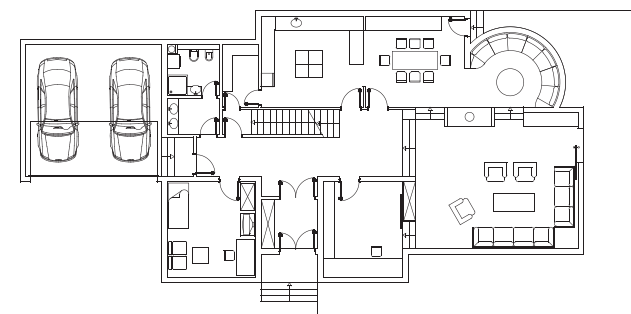

OSNOVA PRIZEMLJA

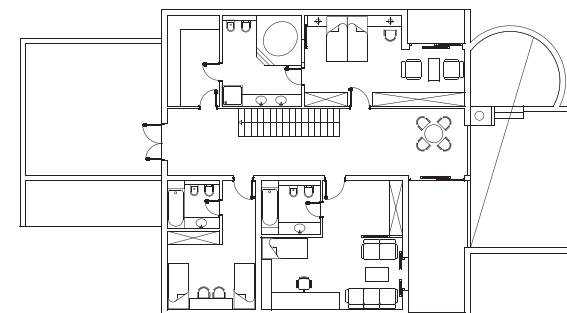

OSNOVA POTKROVLJA



**VILA RAMIĆ** | Individualni stambeni objekat  
Sarajevo  
INVESTITOR: RAMIĆ H. LOKACIJA: SARAJEVO STATUS: IDEJA (2007)

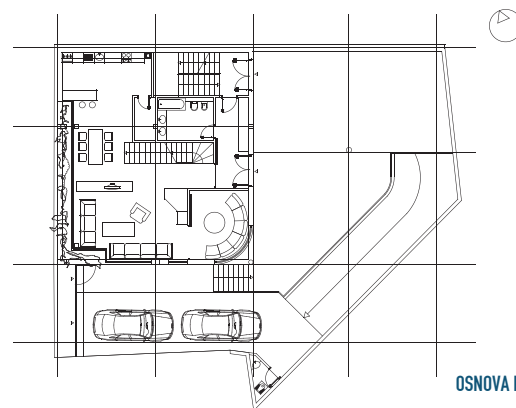

OSNOVA PRIZEMLJA

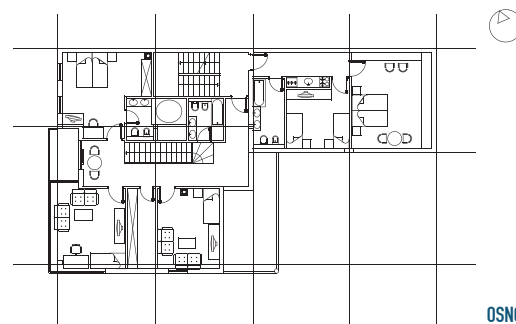

OSNOVA I KATA

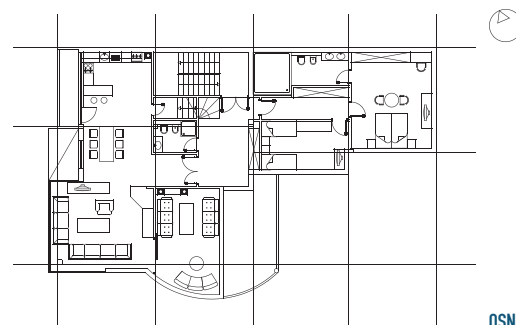

OSNOVA II KATA



**VILA VELBOS** | Individualni stambeni objekat  
Sarajevo  
INVESTITOR: VELBOS D.O.O. LOKACIJA: SARAJEVO STATUS: IDEJA (2007)

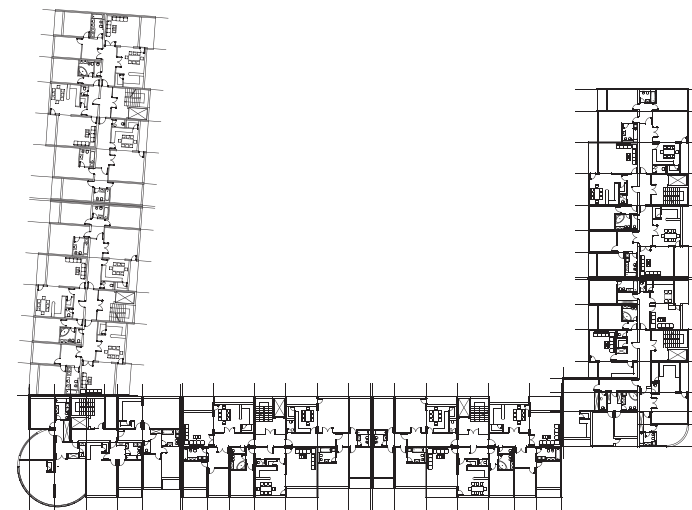

OSNOVA KARAKTERISTIČNE ETAŽE STAMBENOG DIJELA

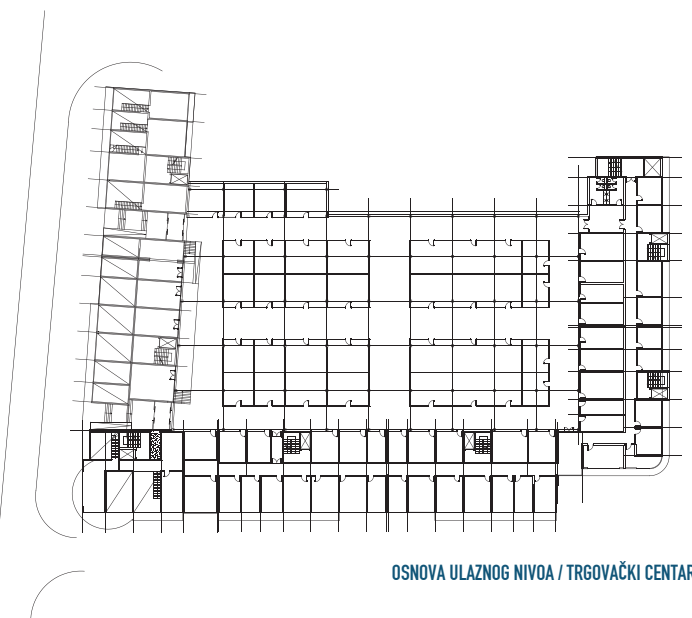

OSNOVA ULAZNOG NIVO / TRGOVAČKI CENTAR /



**ASTRO (VINOJUG 3)** Stambeno-poslovni objekat  
Sarajevo  
INVESTITOR: VINOJUG D.O.O. LOKACIJA: SARAJEVO STATUS: IDEJA (2007)



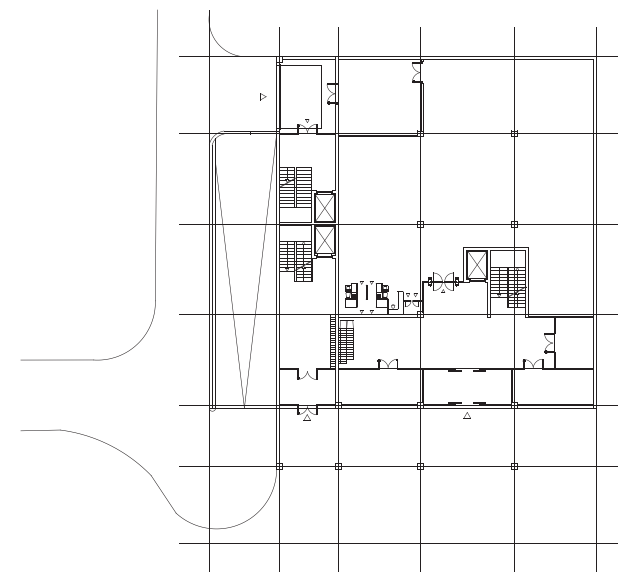

OSNOVA PRIZEMLJA

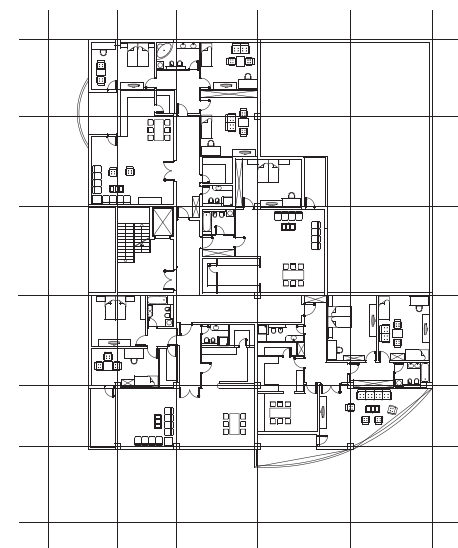

OSNOVA III-VIII KATA



**NIZO** | Stambeno-poslovni objekat  
Sarajevo  
INVESTITOR: RAMIĆ N. LOKACIJA: SARAJEVO STATUS: IDEJA (2007)



OSNOVA PRIZEMLJA



OSNOVA II, III, VI, VII KATA



**VELBOS** | Stambeno-poslovni objekat  
Sarajevo  
INVESTITOR: VELBOS D.O.O. LOKACIJA: SARAJEVO STATUS: IDEJA (2007)



KARAKTERISTIČNA OSNOVA STAMBENOG DIJELA

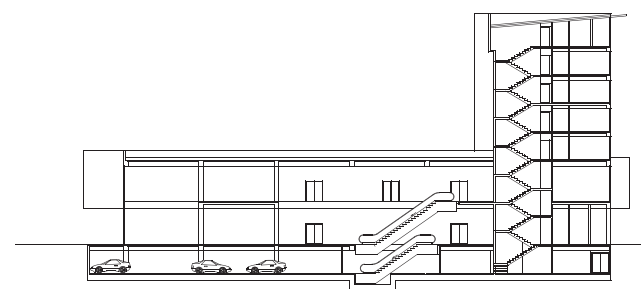

PRESJEK



**LIMORAD** | Stambeno-poslovni objekat  
 Žepče  
 INVESTITOR: LIMORAD D.O.O. LOKACIJA: ŽEPČE STATUS: IDEJA (2007)

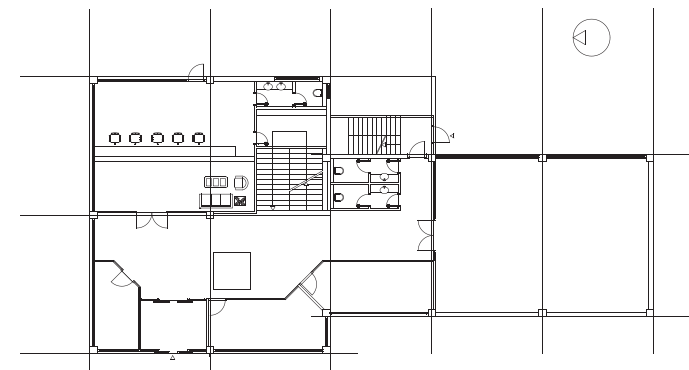

OSNOVA PRIZEMLJA

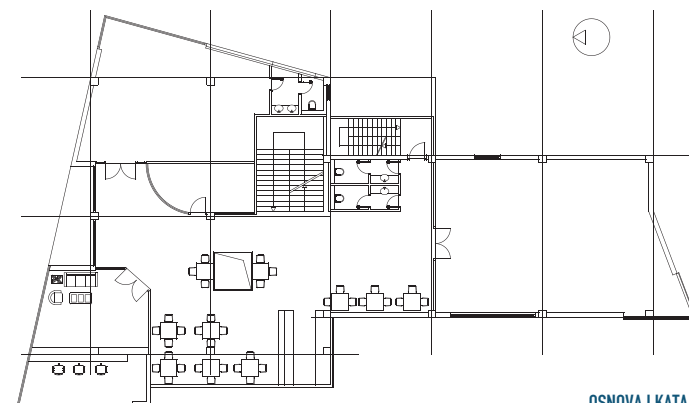

OSNOVA I KATA

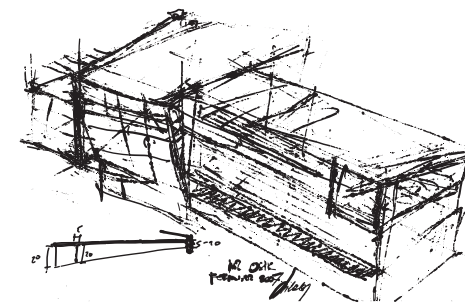

**OSIK** Poslovni centar  
 Osijek, Ilidža  
 INVESTITOR: UDRUŽENJE GRAĐANA OSJEK LOKACIJA: OSJEK, ILIDŽA STATUS: IDEJA (2007)

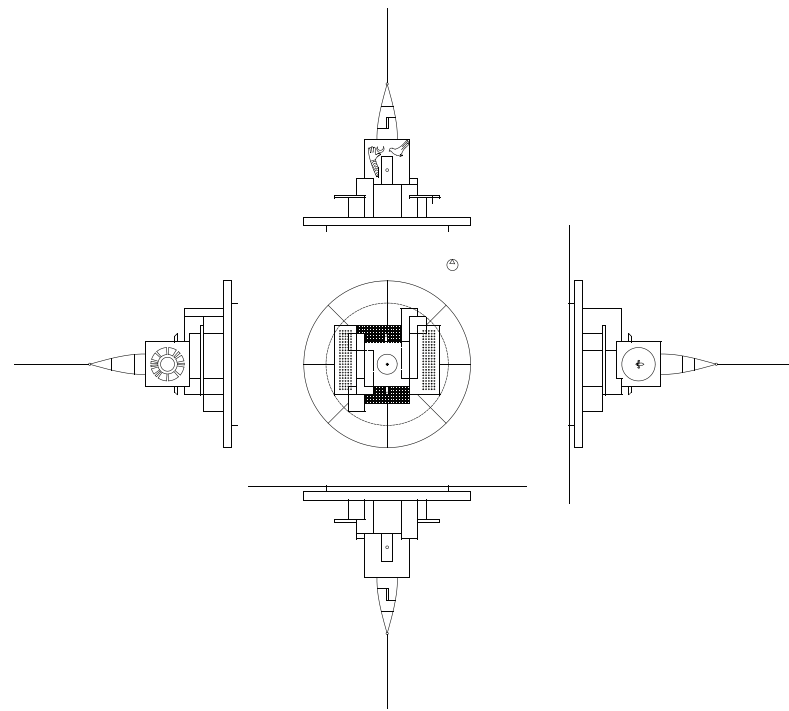
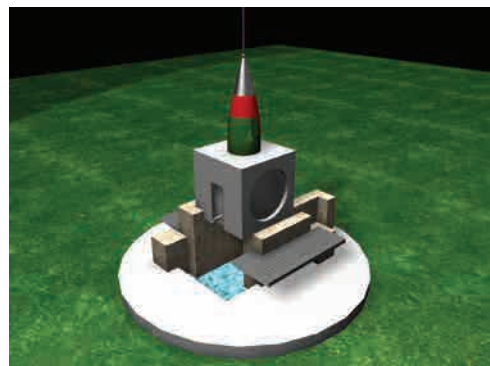

## HAJR ČESMA

OBJEKAT: HAJR ČESMA PRIPADNICIMA PATRIOTSKE LIGE TEOČAK, BIH LOKACIJA: TEOČAK STATUS: IDEJA (1998)

## SPOMEN OBILJEŽJE ZAIMU IMAMOVIĆU

LOKACIJA: GORAŽDE STATUS: IDEJA (1998)

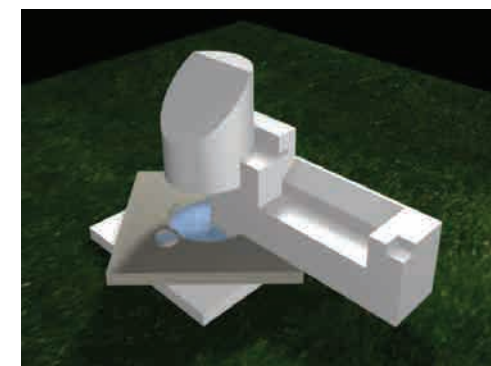
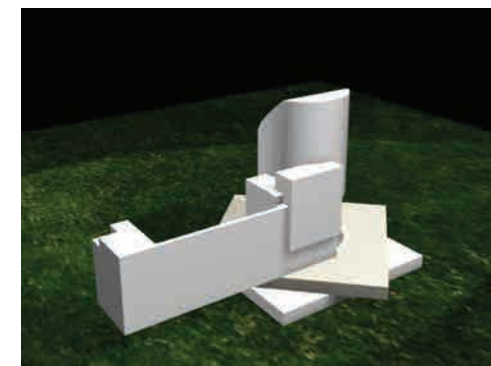
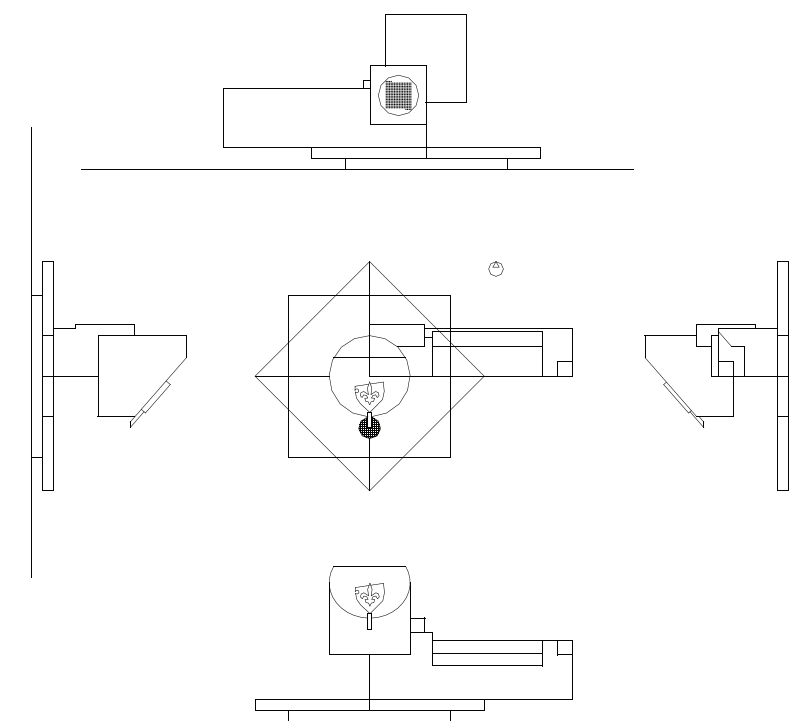

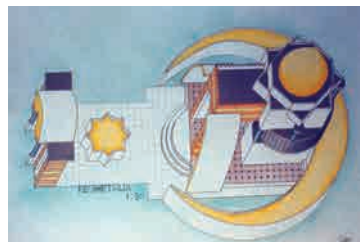
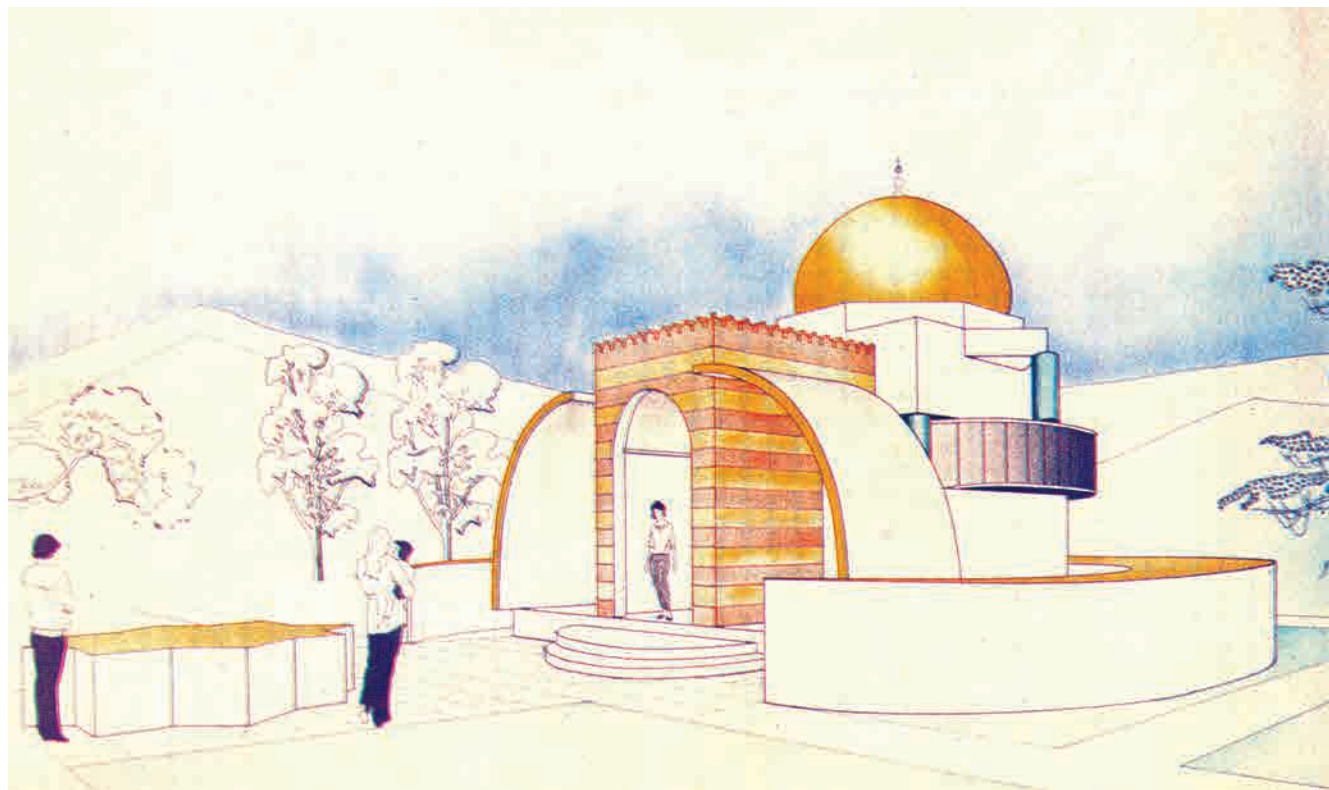

## TURBE KAPETANA HAJRE

OBJEKAT: ŠEHIDSKO MEZARJE PRIPADNIKA PATRIOTSKE LIGE BIH SA TURBETOM KAPETANA HAJRE LOKACIJA: TEOČAK STATUS: IDEJA (1996 - DJELIMIČNO IZVEDENO)

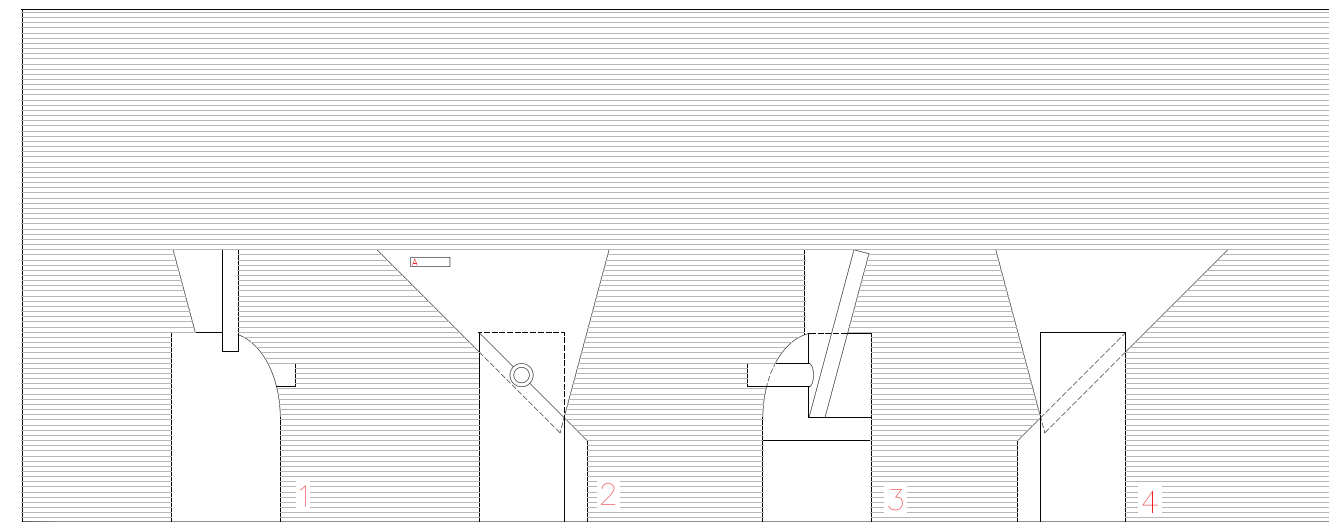

A-MESINGANE PLOČICE SA IMENIMA

0 0,5m 1m

F A S A D E

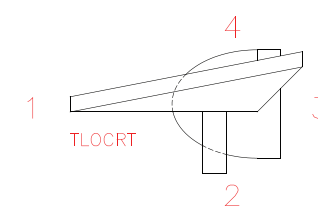

TLOCRT

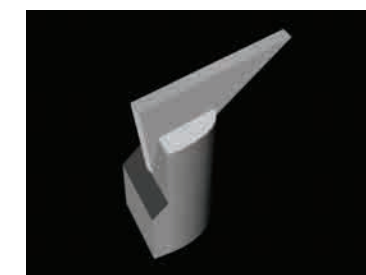
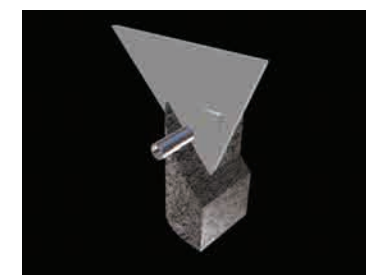

## HAJR ČESMA BORCIMA OPĆINE CENTAR

LOKACIJA: SARAJEVO STATUS: IDEJA (1998)

Sabrija Bilalić rođen 01.02.1966. godine u Teočaku, BiH.

Osnovnu školu završio u Teočaku a srednju građevinsko-tehničku školu u Tuzli.

Godine 1986./87. počinje studiranje na Arhitektonskom fakultetu u Sarajevu, smjer arhitektonsko-projektantski, gdje je i diplomirao u maju 1991. godine.

Od juna 1991. godine do aprila 1992.godine. zaposlen u samostalnoj građevinsko-zanatskoj radnji u Ugljeviku u svojstvu rukovodioca gradilišta.

Ratno vrijeme provodi kao pripadnik OS Armije R BiH, zatim MUP-a R BiH. Od avgusta 1995. do februara 1996. godine zaposlen u organima uprave Općine Teočak.

Od februara do septembra 1996. godine, zaposlen u Arhitektonskom ateljeu "Ambijent" u Tuzli na mjestu projektanta.

Od septembra 1996. godine zaposlen na Arhitektonskom fakultetu u Sarajevu, na mjestu asistenta na predmetu Privredne zgrade, gdje 2000. godine biva ponovo reizabran.

Dana 20.01.2004. godine na Arhitektonskom fakultetu, Univeziteta u Sarajevu, uspješno brani magistarki rad i time stiče naučno zvanje magistra tehničkih nauka iz oblasti "arhitekture i urbanizma".

Od maja 2004. godine radi na Katedre za projektovanje Arhitektonskog fakulteta U Sarajevu u zvanju višeg asistenta.



**Sponzori izložbe:**

BS Projekt d.o.o. Sarajevo  
Butmir d.o.o. Sarajevo  
Bosmal d.o.o. Sarajevo  
Connit d.o.o. Tuzla  
Konmont d.o.o. Tuzla  
Eurosafalt d.o.o. Sarajevo  
Hano d.o.o. Sarajevo  
Mountain d.o.o. Sarajevo  
IN d.o.o. Sarajevo  
Velbos d.o.o. Begov Han-Žepče  
Balco company d.o.o. Sarajevo  
Megakop d.o.o. Drašje  
Vinojug d.o.o. Sarajevo  
Alpam d.o.o. Tuzla  
Integralelektro d.o.o. Visoko  
Nerzz Bešlagić d.o.o. Visoko  
Brass d.o.o. Sarajevo  
Ugarak produkt d.o.o. Visoko

**Realizaciju izložbe pomogli:**  
Arhitektonski fakultet u Sarajevu



Galerija MAK  
Samra Bilalić